



## Type VDSB/B sequence valves

- Differential acting

Technical specifications and diagrams are measured with mineral oil of 46 cSt viscosity at 40°C (104°F) temperature.

	<b>VDSB/B 38</b>	<b>VDSB/B 12</b>	<b>VDSB/B 34</b>	<b>VDSB/B 100</b>	
Nominal flow	30 l/min (7.9 US gpm)	60 l/min (16 US gpm)	120 l/min (31.7 US gpm)	200 l/min (52.8 US gpm)	
Max. pressure	Aluminium body = 210 bar (3050 psi) Steel body = 350 bar (5100 psi)				
Fluid	mineral based oil				
Viscosity	10-200 cSt				
Max. level of contamination	18/16/13 ISO4406				
Fluid temperature	with NBR seals from -20°C (-4°F) to 80°C (176°F)				
Environmental temp. for working conditions	from -40°C (-40°F) to 100°C (212°F)				
Weight	<i>alum.</i>	0.60 kg (1.32 lb)	0.80 kg (1.76 lb)	1.13 kg (2.49 lb)	2.10 kg (4.63 lb)
	<i>steel</i>	1.06 kg (2.34 lb)	1.53 kg (3.37 lb)	2.33 kg (5.14 lb)	4.82 kg (10.63 lb)

NOTE - For different conditions, please contact Walvoil Sales Dpt.

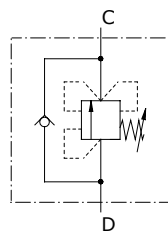

## Dimensions

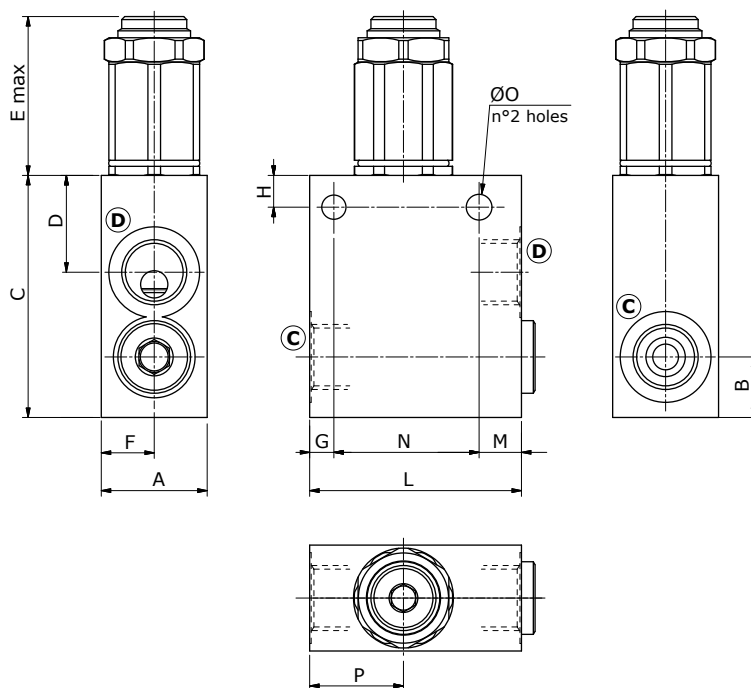

Valve type	All ports
VDSD/B 38	G3/8
VDSD/B 12	G1/2
VDSD/B 34	G3/4
VDSD/B 100	G1"

  

Valve type	All ports
VDSD/B 38/SAE	SAE8
VDSD/B 12/SAE	SAE10
VDSD/B 34/SAE	SAE12
VDSD/B 100/SAE	SAE16

Dimensions are in mm-in

Valve type	A	B	C	D	E max	F	G	ØO	H	L	M	N	P
VDSD/B 38	30-1.18	16-0.63	74-2.91	32,5-1.28	59-2.32	15-0.59	8-0.31	8.5-0.33	11.5-0.45	60-2.36	12-0.47	40-1.57	28-1.10
VDSD/B 38/SAE													
VDSD/B 12	35-1.38	20-0.79	80-3.15	32-1.26	58-2.28	17.5-0.69	8-0.31	8.5-0.33	10.5-0.41	70-2.75	14-0.55	48-1.89	31-1.22
VDSD/B 12/SAE													
VDSD/B 34	40-1.57	22-0.87	90-3.54	34-1.34	58-2.28	20-0.79	10-0.39	10.5-0.41	11-0.43	90-3.54	10-0.39	70-2.75	36-1.42
VDSD/B 34/SAE													
VDSD/B 100	60-2.36	38-1.50	126-4.96	42-1.65	51,5-2.03	30-1.18	12-0.47	12-0.47	12-0.47	90-3.54	18-0.71	60-2.36	36-1.42
VDSD/B 100/SAE													

Ordering codes and description composition

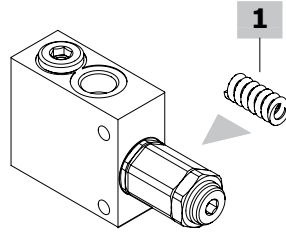
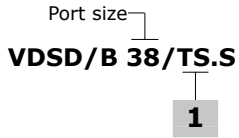

**VDS/B complete valves**

*With differential valve type: standard setting 160 bar at 5 l/min (2320 psi at 1.32 US gpm)*

TYPE	CODE	DESCRIPTION
<b>Configuration with G3/8 standard thread</b>		
VDS/B 38/TS.S	1204021102	Aluminium body, setting range 50-220 bar (725-3200 psi)
VDS/B 38/TS.S/ac	1204022101	Steel body, as previous one
<b>Configuration with G1/2 standard thread</b>		
VDS/B 12/TS.S	1204031102	Aluminium body, setting range 50-220 bar (725-3200 psi)
VDS/B 12/TS.S/ac	1204032100	Steel body, as previous one
<b>Configuration with G3/4 standard thread</b>		
VDS/B 34/TS.S	1204041102	Aluminium body, setting range 50-220 bar (725-3200 psi)
VDS/B 34/TS.S/ac	1204042100	Steel body, as previous one
<b>Configuration with G1" standard thread</b>		
VDS/B 100/TS.S	1204051102	Aluminium body, setting range 50-220 bar (725-3200 psi)
VDS/B 100/TS.S/ac	1204052100	Steel body, as previous one
<b>Configuration with SAE8 standard thread</b>		
VDS/B 38/TS.S/SAE	1204021200	Aluminium body, setting range 50-220 bar (725-3200 psi)
<b>Configuration with SAE10 standard thread</b>		
VDS/B 12/TS.S/SAE	1204031201	Aluminium body, setting range 50-220 bar (725-3200 psi)
<b>Configuration with SAE12 standard thread</b>		
VDS/B 34/TS.S/SAE	1204041200	Aluminium body, setting range 50-220 bar (725-3200 psi)
<b>Configuration with SAE16 standard thread</b>		
VDS/B 100/TS.S/SAE	1204051200	Aluminium body, setting range 50-220 bar (725-3200 psi)

For other steel body configurations, SAE thread and configurations with FPM (Viton) seals please contact our Sales Dept.

**1 Pressure setting springs**

TYPE	CODE	DESCRIPTION
<b>For VDS/B 38 valve</b>		
TV	3ML1144000	Setting range 20-100 bar (290-1450 psi)
TS	3ML1144001	Setting range 50-220 bar (725-3200 psi)
TR	3ML1144002	Setting range 100-350 bar (1450-5100 psi)
<b>For VDS/B 12, 34 and 100 valves</b>		
TV	3ML1164000	Setting range 20-100 bar (290-1450 psi)
TS	3ML1164001	Setting range 50-220 bar (725-3200 psi)
TR	3ML1164002	Setting range 100-350 bar (1450-5100 psi)

### Rating diagrams

**VSD/B 38 pressure vs. flow**

Std. setting at 5 l/min (1.32 US gpm)

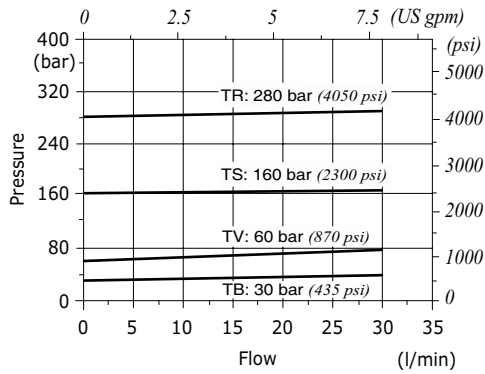

**VSD/B 12 pressure vs. flow**

Std. setting at 5 l/min (1.32 US gpm)

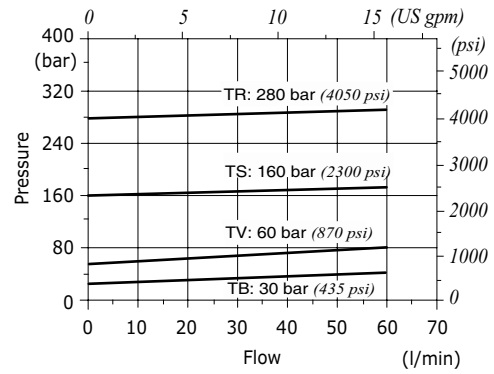

**VSD/B 34 pressure vs. flow**

Std. setting at 5 l/min (1.32 US gpm)

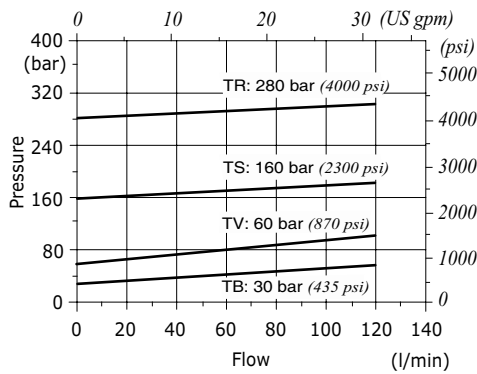

**VSD/B 100 pressure vs. flow**

Std. setting at 5 l/min (1.32 US gpm)

